

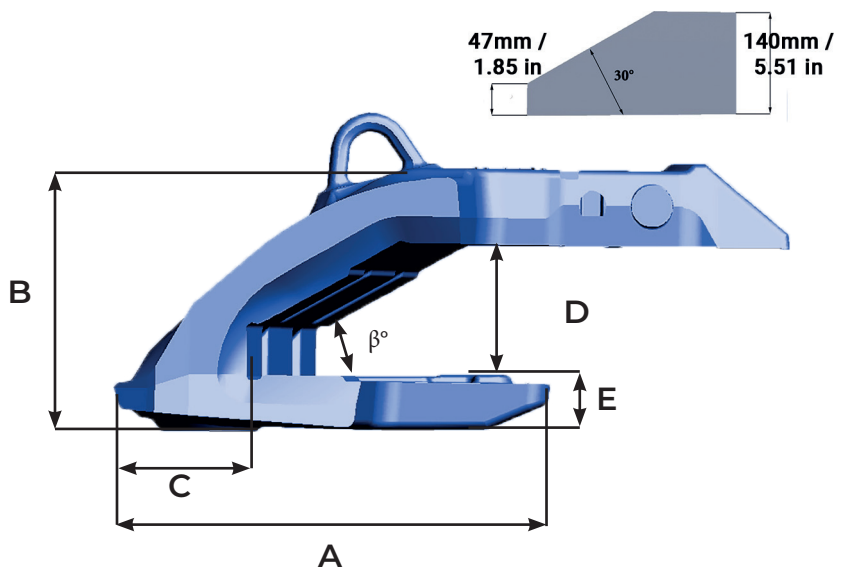

Bucket equipment
for quarrying & mining

TKSH EXC 420 140 L

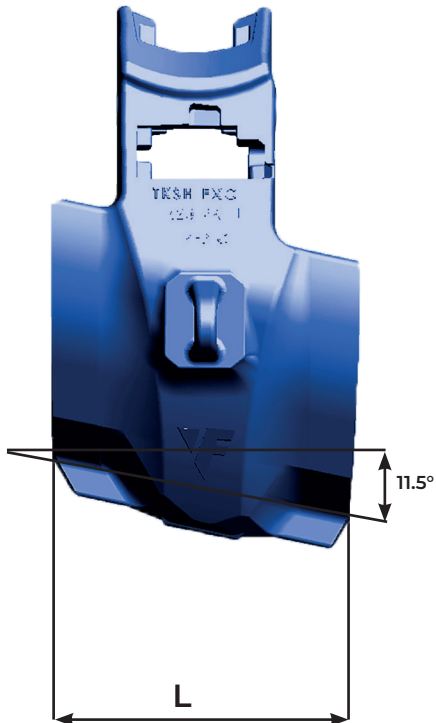

Référence Part number	Poids Weight Kg/Lbs	L mm/in	A mm/in	B mm/in	C mm/in	D mm/in	E mm/in	β°
TKSH EXC 420 140 L	150 330.69	420 16.53	437 17.20	286 11.26	152 5.98	146 5.75	55 2.17	30°

