

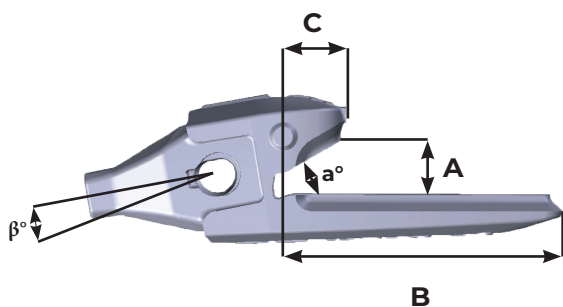

TURNKEY[®]
GRIZZLY

Bucket equipment
for construction

T7 1240 10°

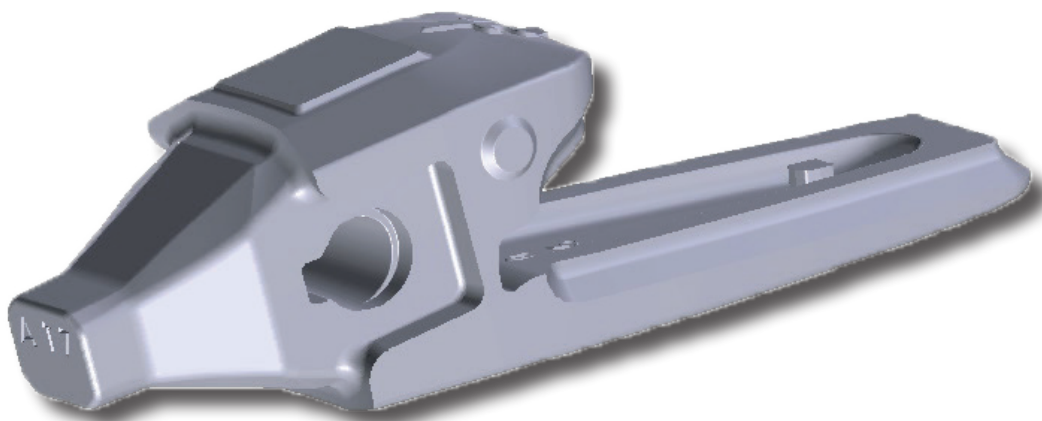

Référence Part number	Poids Weight Kg/Lbs	A mm/in	B mm/in	C mm/in	L mm/in	a°	β°
T7 1240 10°	10.7 23.59	41 1.61	216 8.50	53 2.08	106 4.17	30°	10°

