

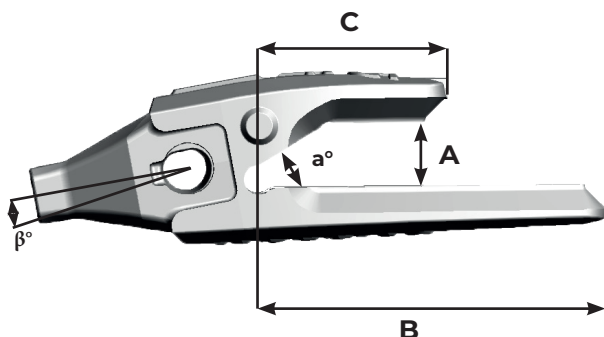

TURNKEY[®]
GRIZZLY

Bucket equipment
for construction

T5 1335 10°



Référence Part number	Poids Weight Kg/Lbs	A mm/in	B mm/in	C mm/in	L mm/in	a°	β°
T5 1335 10°	6.83 15.06	36 1.41	200 7.87	110 4.33	89 3.50	30°	10°

