

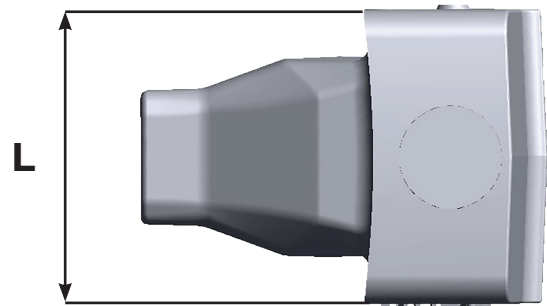

Bucket equipment
for quarrying & mining

TKN11 NS

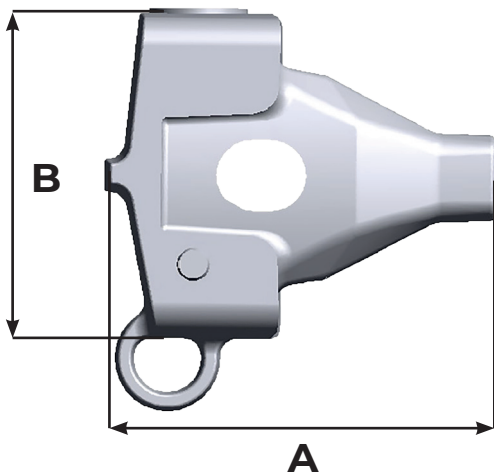

Référence Part number	Poids Weight Kg/Lbs	A mm/in	B mm/in	L mm/in
TKN11 NS	26.3 57.98	236 9.29	198 7.80	168 6.61

