

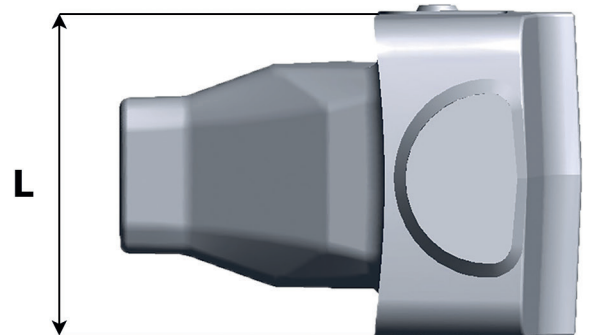

Bucket equipment
for quarrying & mining

TKN10 NS

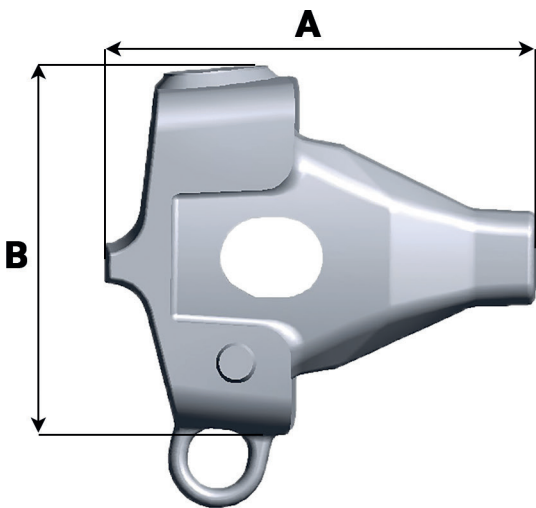

Référence Part number	Poids Weight Kg/Lbs	A mm/in	B mm/in	L mm/in
TKN10 NS	16.5 36.38	228 8.98	181 7.13	150 5.86

