

Fiche Produit / Reference sheet

TKSH EXC 280 70 L

Turnkey®

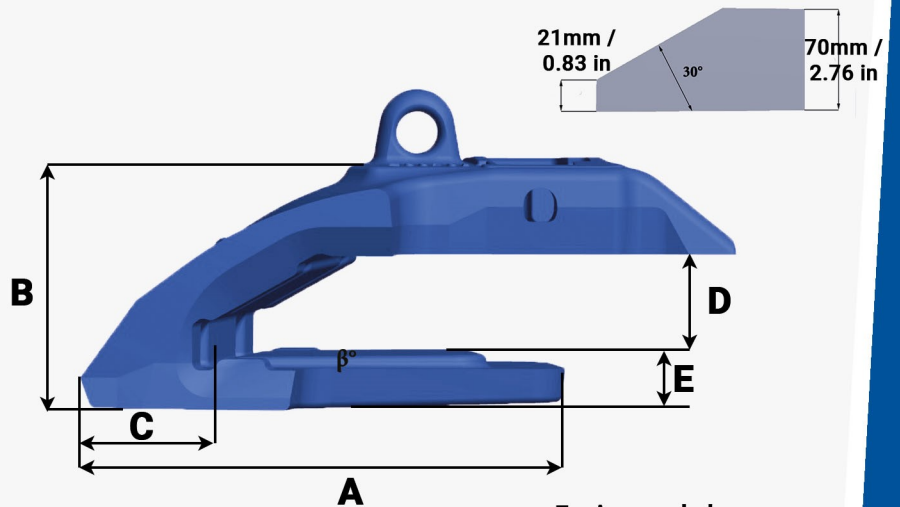
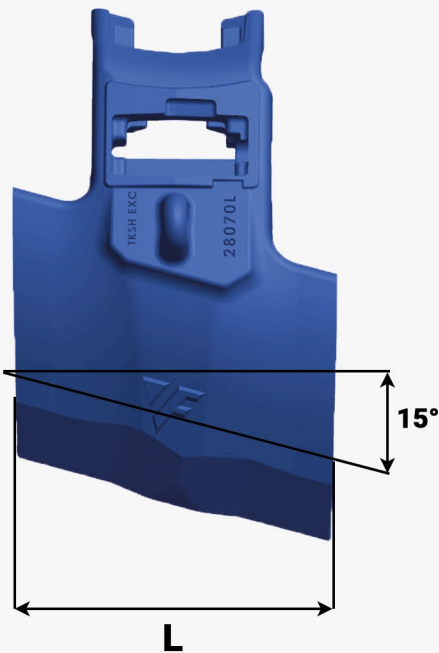
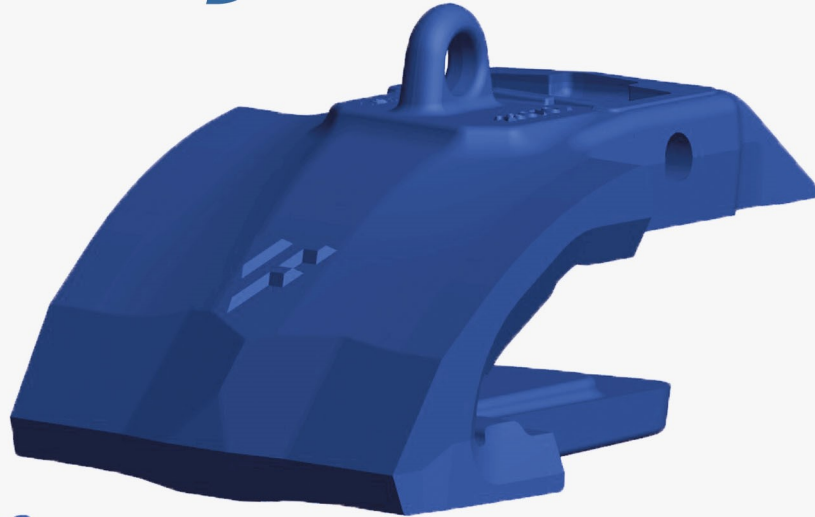

Epaisseur de lame
Blade Thickness
70mm / 2.76 in

Référence Part Number	Poids Weight (Kg/Lbs)	L (mm/in)	A (mm/in)	B (mm/in)	C (mm/in)	D (mm/in)	E (mm/in)	β°
TKSH EXC 280 70 L	38 83.77	280 11.02	300 11.81	164 6.45	73 2.87	73 2.87	33 1.33	30°

Feurst

www.feurst.fr