

Fiche Produit / Reference sheet

TKSH EXC 280 70 C

Turnkey®

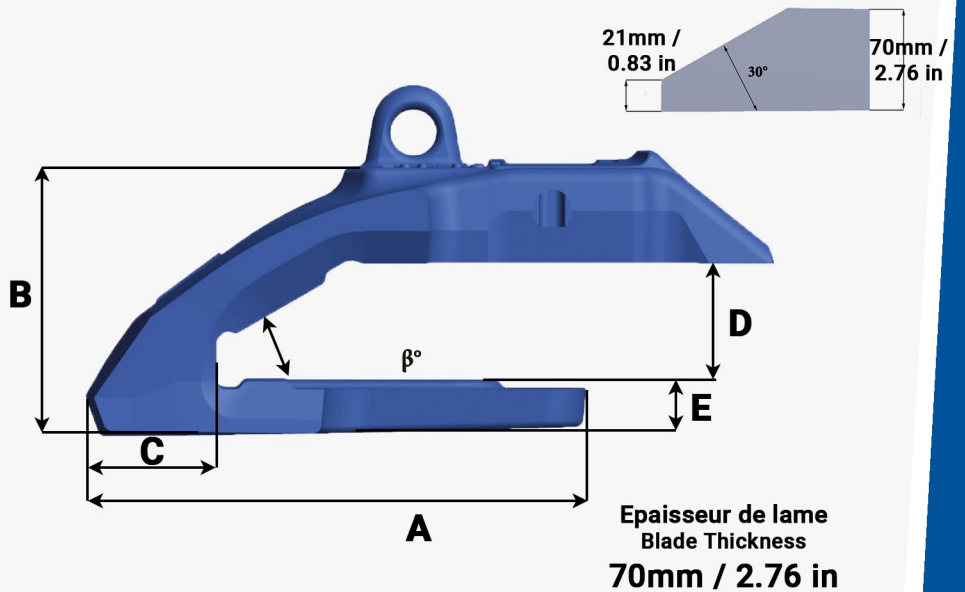

Référence Part Number	Poids Weight (Kg/Lbs)	L (mm/in)	A (mm/in)	B (mm/in)	C (mm/in)	D (mm/in)	E (mm/in)	β°
TKSH EXC 280 70 C	38.25 84.33	280 11.02	300 11.81	164 6.45	74 2.91	73 2.87	33 1.33	30°